

Metal Oxide Varistors (MOV) Data Sheet

Features

- Fast responding to transient over-voltage
- Large absorbing transient energy capability
- Low clamping ratio and no follow-on current
- Meets MSL level 1, per J-STD-020
- Operating Temperature: -40°C ~ +105°C & -40°C ~ +125°C
- Storage Temperature: -40°C ~ +125°C

Applications

- Power supply, Telecommunication, Smart meter, or PLC protection
- Surge protection in consumer electronics
- Surge protection in industrial electronics
- Surge protection in electronic home appliances, gas and petroleum appliances
- Relay and electromagnetic valve surge absorption

Part Number Code

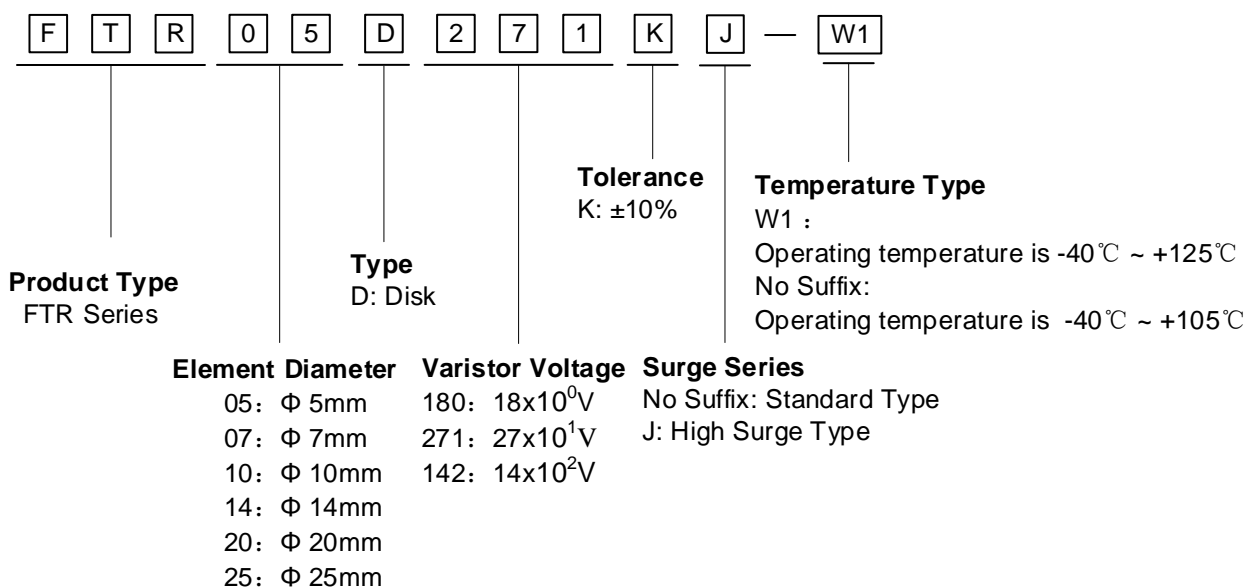

Electrical Characteristics

Part Number		Maximum Allowable Voltage		Varistor Voltage	Maximum Clamping Voltage		Withstanding Surge current		Maximum Energy (10/1000μs)		Rated Power	Dimension T _{max}
Standard	High Surge	V _{AC} (V)	V _{DC} (V)	V _{1mA} (V)	I _F (A)	V _C (V)	(A) Standard	(A) High Surge	(J) Standard	(J) High Surge	(W)	(mm)
FTR05D180K	FTR05D180KJ	11	14	18(15~21.6)	1	40	100	250	0.4	0.6	0.01	5.0
FTR05D220K	FTR05D220KJ	14	18	22(19.5~26)	1	48	100	250	0.5	0.7	0.01	5.0
FTR05D270K	FTR05D270KJ	17	22	27(24~31)	1	60	100	250	0.6	0.9	0.01	5.0
FTR05D330K	FTR05D330KJ	20	26	33(29.5~36.5)	1	73	100	250	0.8	1.1	0.01	5.0
FTR05D390K	FTR05D390KJ	25	31	39(35~43)	1	80	100	250	0.9	1.2	0.01	5.0
FTR05D470K	FTR05D470KJ	30	38	47(42~52)	1	104	100	250	1.1	1.5	0.01	5.0
FTR05D560K	FTR05D560KJ	35	45	56(50~62)	1	123	100	250	1.3	1.8	0.01	5.0
FTR05D680K	FTR05D680KJ	40	56	68(61~75)	1	145	100	250	1.6	2.2	0.01	5.0
FTR05D820K	FTR05D820KJ	50	65	82(74~90)	5	150	400	800	2.5	4	0.1	5.0
FTR05D101K	FTR05D101KJ	60	85	100(90~110)	5	177	400	800	3	4.1	0.1	3.8
FTR05D121K	FTR05D121KJ	75	100	120(108~132)	5	210	400	800	4	4.9	0.1	4.0
FTR05D151K	FTR05D151KJ	95	125	150(135~165)	5	260	400	800	4.1	6.5	0.1	3.6
FTR05D181K	FTR05D181KJ	115	150	180(162~198)	5	320	400	800	4.9	7.5	0.1	3.7
FTR05D201K	FTR05D201KJ	130	170	200(180~220)	5	355	400	800	6.5	8.5	0.1	3.8
FTR05D221K	FTR05D221KJ	140	180	220(198~242)	5	380	400	800	7.5	9	0.1	3.9
FTR05D241K	FTR05D241KJ	150	200	240(216~264)	5	415	400	800	8	10.5	0.1	4.0
FTR05D271K	FTR05D271KJ	175	225	270(243~297)	5	475	400	800	8.5	11	0.1	4.2
FTR05D301K	FTR05D301KJ	190	250	300(270~330)	5	520	400	800	9	12	0.1	4.3
FTR05D331K	FTR05D331KJ	210	275	330(297~363)	5	570	400	800	9.5	13	0.1	4.3
FTR05D361K	FTR05D361KJ	230	300	360(324~396)	5	620	400	800	10	16	0.1	4.5
FTR05D391K	FTR05D391KJ	250	320	390(351~429)	5	675	400	800	12	17	0.1	4.6
FTR05D431K	FTR05D431KJ	275	350	430(387~473)	5	745	400	800	13	20	0.1	4.8
FTR05D471K	FTR05D471KJ	300	385	470(423~517)	5	810	400	800	15	21	0.1	5.0
FTR05D511K	FTR05D511KJ	320	415	510(459~561)	5	845	400	800	16	22.5	0.1	5.2
FTR05D561K	FTR05D561KJ	350	460	560(504~616)	5	920	400	800	16.8	24	0.1	5.4
FTR05D621K	FTR05D621KJ	385	505	620(558~682)	5	1025	400	800	17.7	25	0.1	5.7
FTR05D681K	FTR05D681KJ	420	560	680(612~748)	5	1120	400	800	21	29	0.1	6.0
FTR05D751K	FTR05D751KJ	460	615	750(675~825)	5	1240	400	800	22.4	32	0.1	6.1

Notes: 1. The tolerance of varistor voltage between 18V and 27V is more than 10%.

2. Leakage Current (@83% of V_{1mA}): IR≤50μA (180K~680K) ; IR≤25μA (820K~112K)

Dimensions

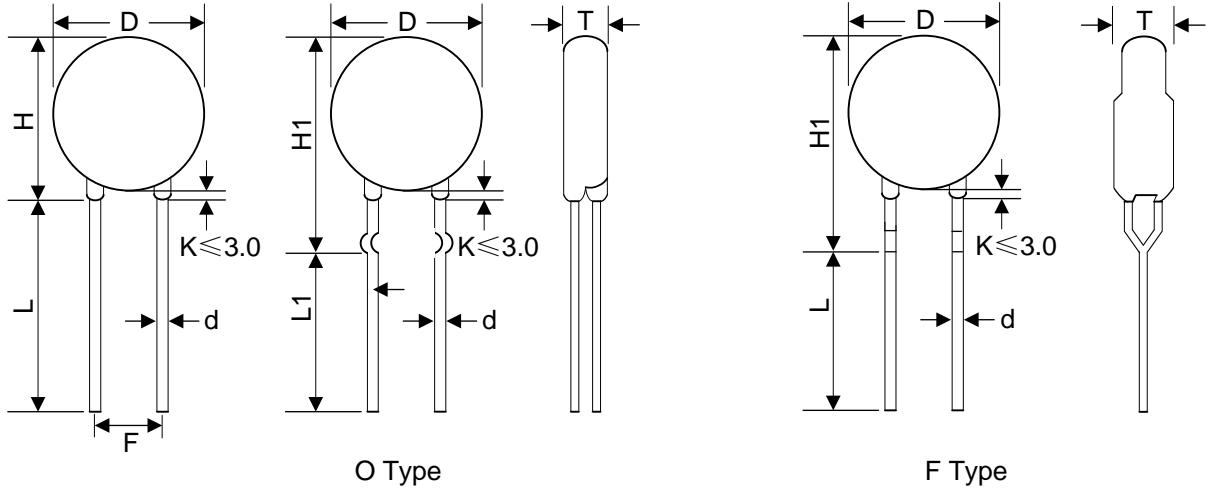

Symbol	H(max.)	H1(Max.)	L(min.)	L1(min.)	D (max.)	F(±0.8)	d(±0.05)	Tmax
Dimension(mm)	9.5	11.5	20	15	7	5	0.6	Please refer to the Electrical Characteristics Table

Marking Code

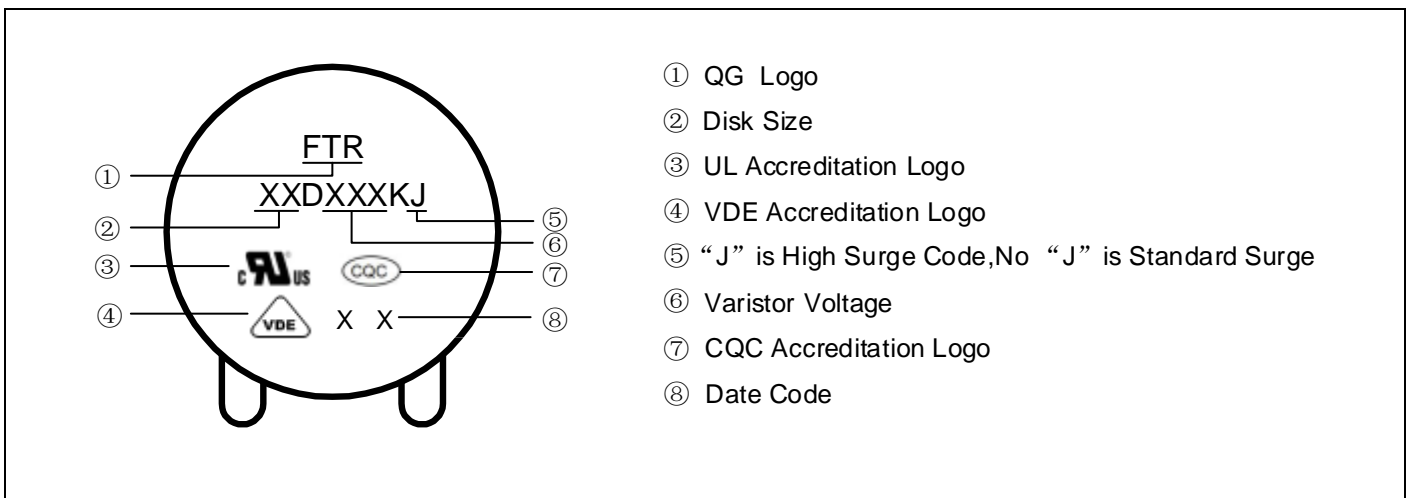

Electrical Ratings

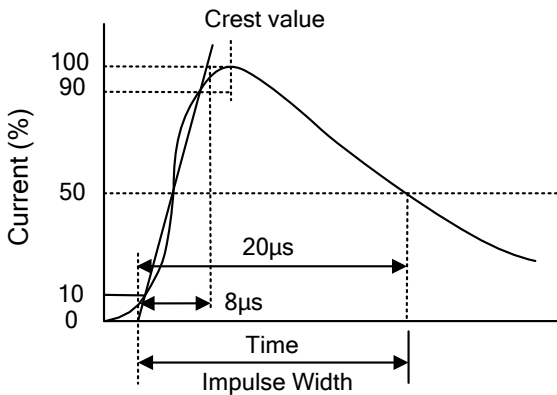
Items	Test Condition/Description	Requirement					
Varistor Voltage	The voltage between two terminals with the specified measuring current 1mA.DC applied is called Vb.	To meet the Specified value					
Maximum Allowable Voltage	The recommended maximum sine wave voltage (RMS) or the Maximum DC voltage can be applied continuously.						
Maximum Clamping Voltage	<p>The maximum voltage between two terminals with the specification standard impulse current. Applied waveform: 8/20μs</p> 						
Rated Wattage	The maximum average power that can be applied within the specified ambient temperature.						
Energy	The maximum energy within the varistor voltage change of ±10% when one impulse of 10/1000μs or 2ms is applied.						
Withstanding Surge Current	The maximum current within the varistor voltage change of ±10% with the standard impulse current (8/20μs) applied one time.						
Varistor Voltage Temp. Coefficient	$\left \frac{V_{1mA@85^{\circ}C} - V_{1mA@25^{\circ}C}}{V_{1mA@25^{\circ}C}} \times \frac{1}{60} \times 100\%(\%/^{\circ}C) \right $ $\left \frac{V_{1mA@-40^{\circ}C} - V_{1mA@25^{\circ}C}}{V_{1mA@25^{\circ}C}} \times \frac{1}{65} \times 100\%(\%/^{\circ}C) \right $	≤0.05%/°C					
Surge Life	<p>The change of Vb shall be measured after the impulse listed below which is applied 10,000 times continuously with the interval of ten seconds at room temperature.</p> <table border="1" data-bbox="438 1915 1204 2049"> <tbody> <tr> <td rowspan="2">5Φ series</td> <td>180K to 680K</td> <td>10A (8/20μs)</td> </tr> <tr> <td>820K to 751K</td> <td>20A (8/20μs)</td> </tr> </tbody> </table>	5Φ series	180K to 680K	10A (8/20μs)	820K to 751K	20A (8/20μs)	$\frac{\Delta V_b}{V_b} \leq \pm 10\%$
5Φ series	180K to 680K		10A (8/20μs)				
	820K to 751K	20A (8/20μs)					

Mechanical Characteristics

Items	Test conditions / Methods	Specifications								
Tensile Strength of Terminals	<p>Gradually applying the force specified and keeping the unit fixed for 10±1 sec.</p> <table border="1"> <tr> <td>Terminal diameter (mm)</td> <td>Force(kg)</td> </tr> <tr> <td>0.5<d≤0.8</td> <td>1.0</td> </tr> <tr> <td>0.8<d≤1.25</td> <td>2.0</td> </tr> <tr> <td>1.25<d</td> <td>4.0</td> </tr> </table>	Terminal diameter (mm)	Force(kg)	0.5<d≤0.8	1.0	0.8<d≤1.25	2.0	1.25<d	4.0	NO Visible damage Δ V1mA/V1mA ≤5%
Terminal diameter (mm)	Force(kg)									
0.5<d≤0.8	1.0									
0.8<d≤1.25	2.0									
1.25<d	4.0									
Bending Strength of Terminals	<p>Hold specimen and apply the force specified below to each lead. Bend the specimen to 90°, then return to the original position. Repeat the procedure in the opposite direction.</p> <table border="1"> <tr> <td>Terminal diameter (mm)</td> <td>Force(kg)</td> </tr> <tr> <td>0.5<d≤0.8</td> <td>0.5</td> </tr> <tr> <td>0.8<d≤1.25</td> <td>1.0</td> </tr> <tr> <td>1.25<d</td> <td>2.0</td> </tr> </table>	Terminal diameter (mm)	Force(kg)	0.5<d≤0.8	0.5	0.8<d≤1.25	1.0	1.25<d	2.0	NO Visible damage Δ V1mA/V1mA ≤5%
Terminal diameter (mm)	Force(kg)									
0.5<d≤0.8	0.5									
0.8<d≤1.25	1.0									
1.25<d	2.0									
Vibration	<p>Frequency range: 10~55 Hz Amplitude: 0.75mm or 98m/s2 Direction: 3 mutually perpendicular directions, 2hrs each.</p>	NO Visible damage Δ V1mA/V1mA ≤5%								
Solder ability	<p>Solder Temp: 245±5°C Dipping Time: 2±0.5 sec</p>	At least 95% of terminal electrode is covered by new solder								
Resistanceto Soldering Heat	<p>Solder Temp: 260±5°C Dipping Time: 10±1 sec</p>	NO Visible damage Δ V1mA/V1mA ≤5%								

Reliability

Items	Test conditions / Methods	Specifications															
High Temperature Storage	<p>Ambient Temp: 125±2°C Duration: 1000hrs</p>	Δ V1mA/V1mA ≤5%															
Low Temperature Storage	<p>Ambient Temp: -40±2°C Duration: 1000hrs</p>	Δ V1mA/V1mA ≤5%															
Humidity	<p>Ambient Temp: 40±2°C, 90~95% R.H. Duration: 1000hrs</p>	Δ V1mA/V1mA ≤5%															
Temperature Cycle	<p>The conditions shown below shall be repeated 5 cycles</p> <table border="1"> <thead> <tr> <th>Step</th> <th>Temperature (°C)</th> <th>Period (minutes)</th> </tr> </thead> <tbody> <tr> <td>1</td> <td>-40±3</td> <td>30±3</td> </tr> <tr> <td>2</td> <td>Room temperature</td> <td>15±3</td> </tr> <tr> <td>3</td> <td>125±3</td> <td>30±3</td> </tr> <tr> <td>4</td> <td>Room temperature</td> <td>15±3</td> </tr> </tbody> </table>	Step	Temperature (°C)	Period (minutes)	1	-40±3	30±3	2	Room temperature	15±3	3	125±3	30±3	4	Room temperature	15±3	No visible damage ΔV1mA/V1mA ≤5%
Step	Temperature (°C)	Period (minutes)															
1	-40±3	30±3															
2	Room temperature	15±3															
3	125±3	30±3															
4	Room temperature	15±3															
High Temperature Load	<p>Ambient Temp: 105±2°C Duration: 1000hrs Load: Max. Allowable Voltage In AC eara.</p>	ΔV1mA/V1mA ≤5%															
Damp Heat Load	<p>Ambient Temp: 40±2°C, 90~95% R.H. Duration: 1000hrs Load: Max. Allowable Voltage</p>	No visible damage ΔV1mA/V1mA ≤5%															
Voltage Proof	Metal balls method, 2500Vac 1 min.	No visible damage															

Soldering Recommendation

Wave Lead Free Soldering Recommendation

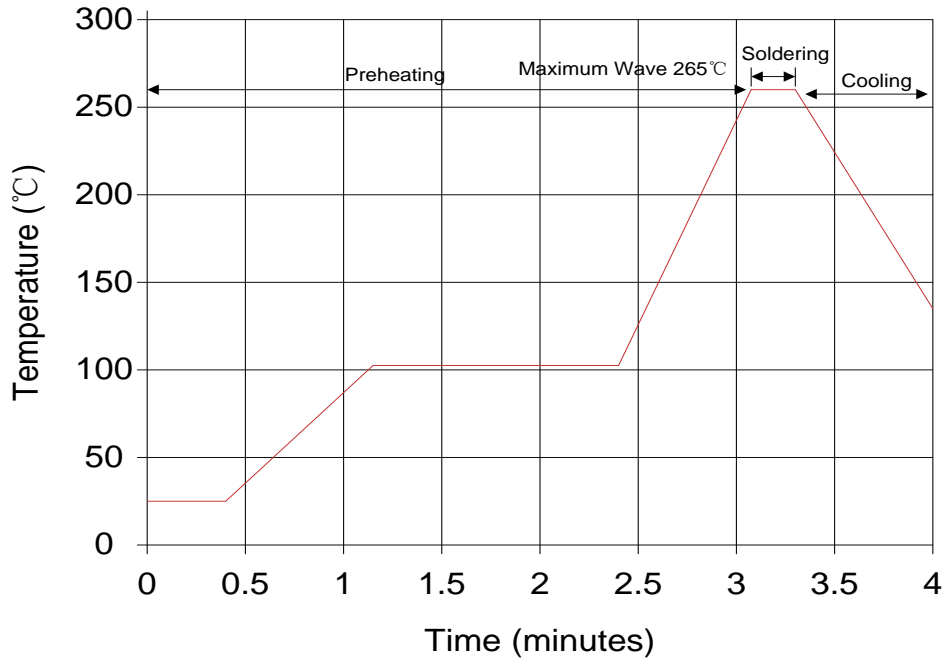

Item	Conditions
Peak Temperature	265°C
Dipping Time	10 seconds(max.)
Soldering	1 time

Recommendation Reworking Conditions with Soldering Iron

Item	Conditions
Temperature of Soldering Iron-tip	360°C(max.)
Soldering Time	3 seconds(max.)
Distance from Varistor	2mm (min.)

Maximum Leakage Current and Maximum Clamping Voltage Curve

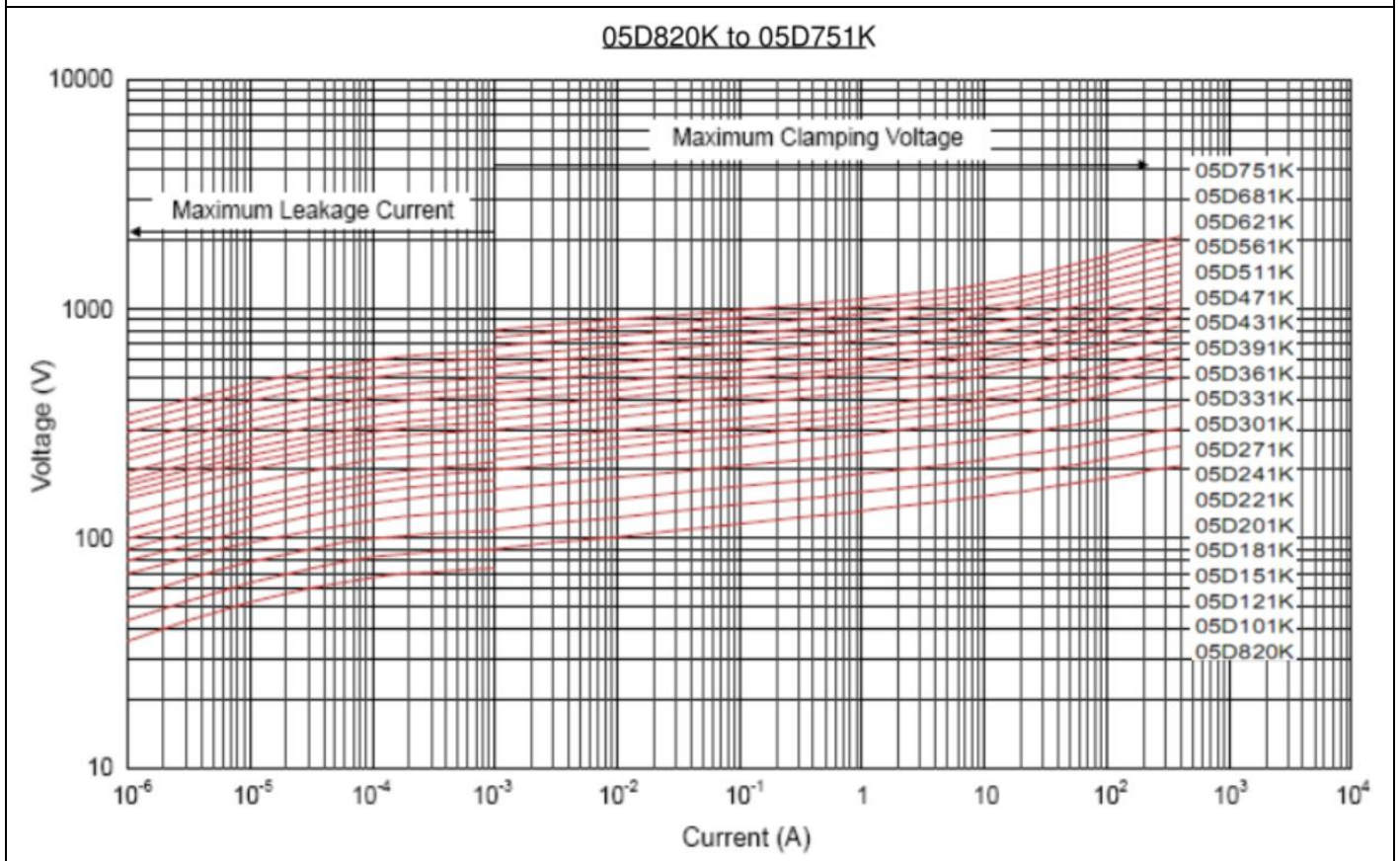
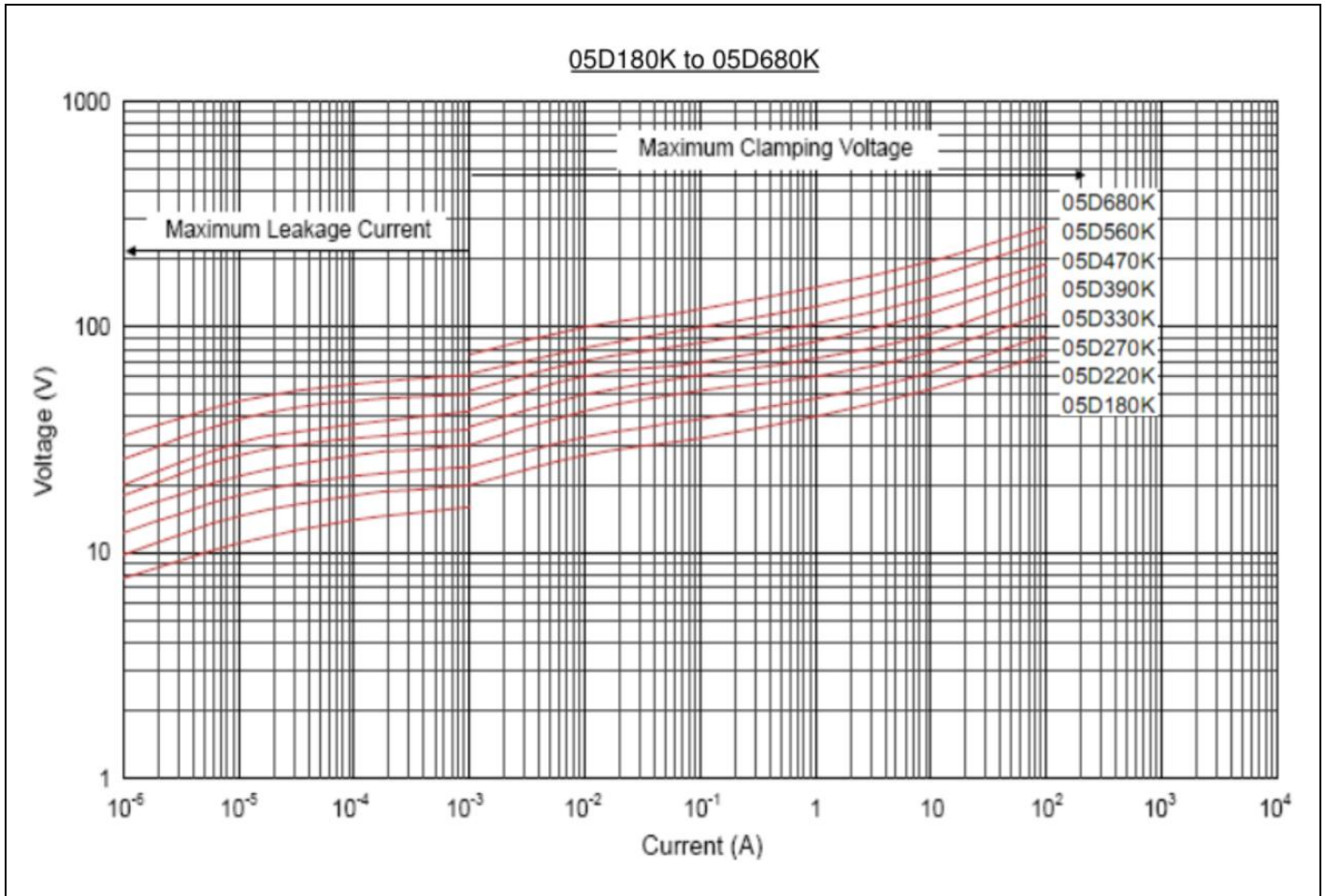

Maximum Leakage Current and Maximum Clamping Voltage Curve

05D180KJ to 05D680KJ

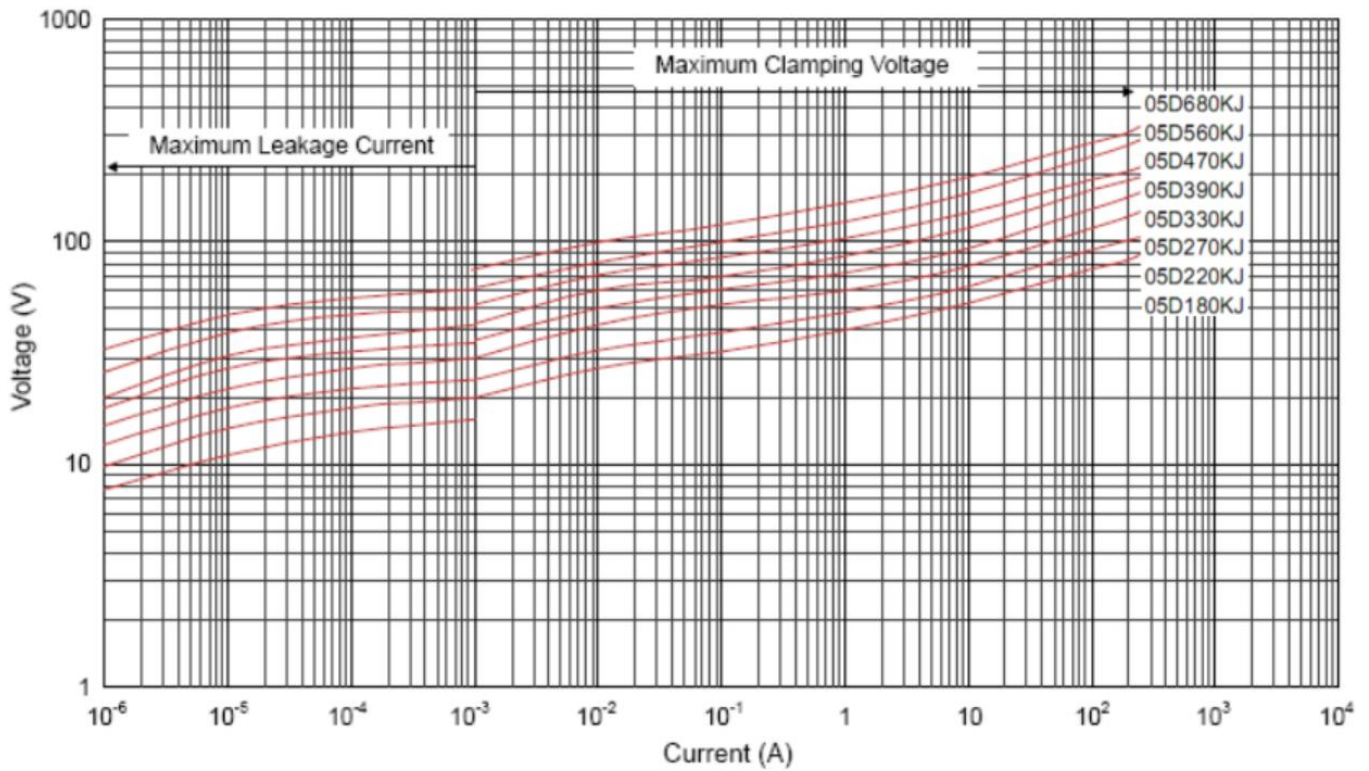

05D820KJ to 05D751KJ

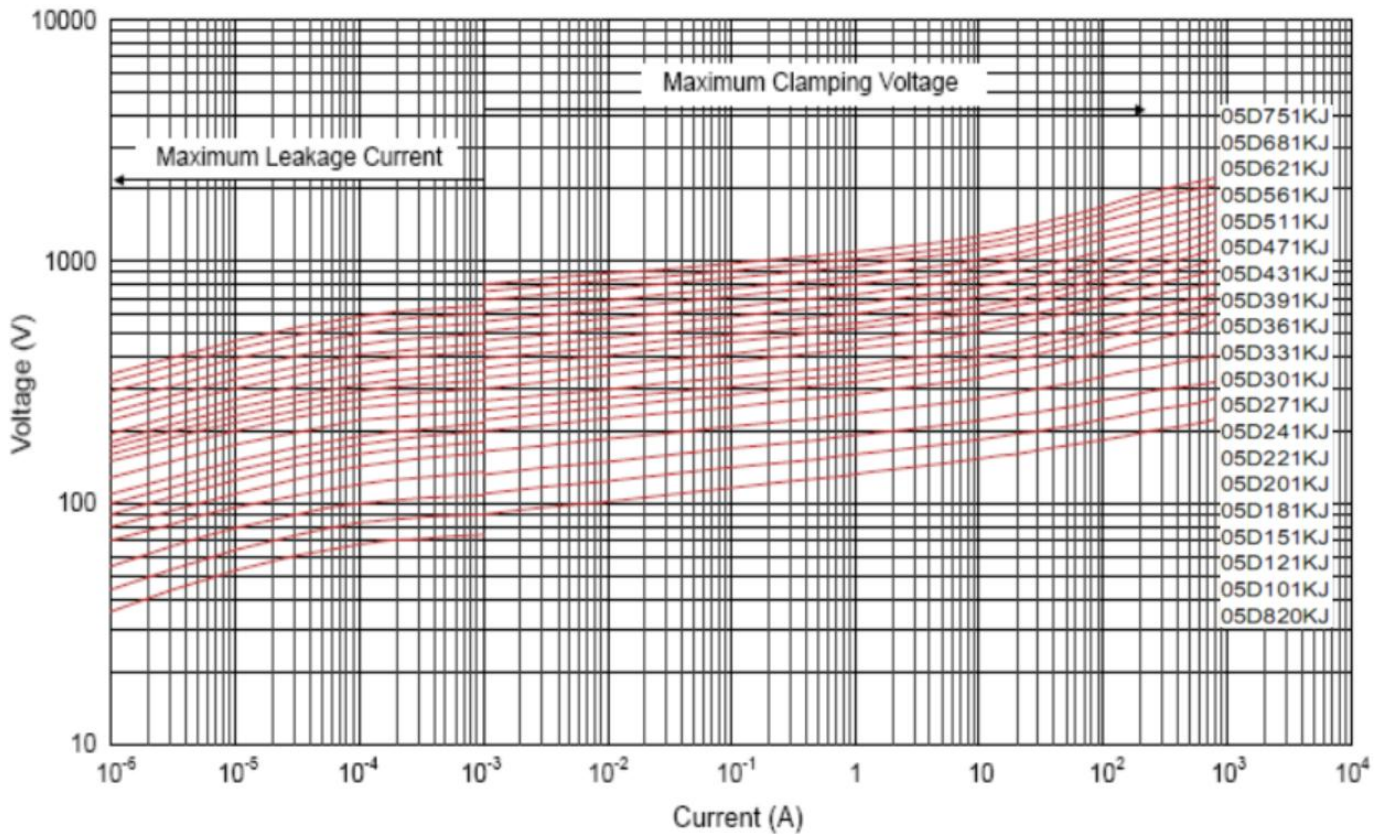

Maximum Surge Current Derating Curve

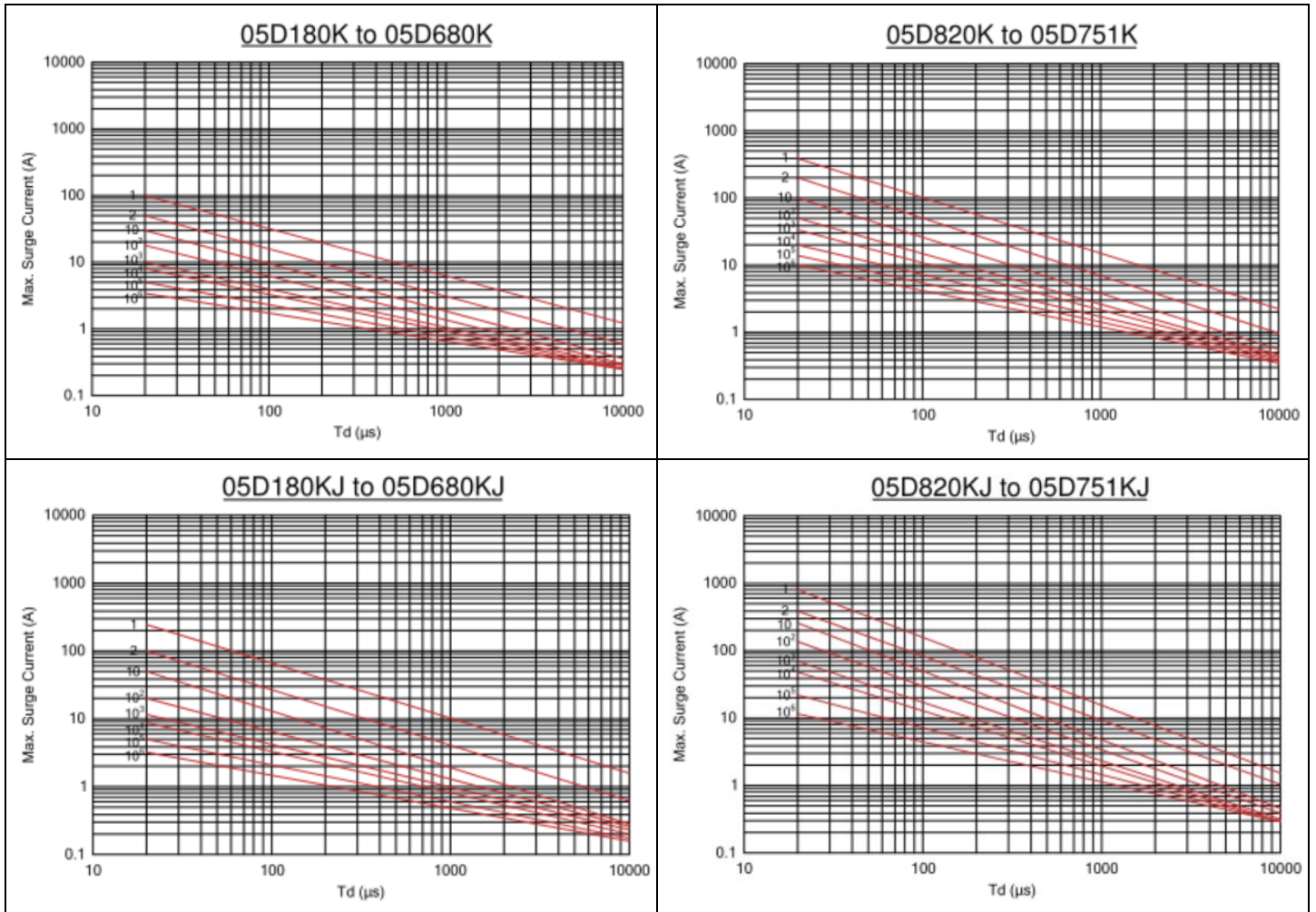

Taping Dimensions

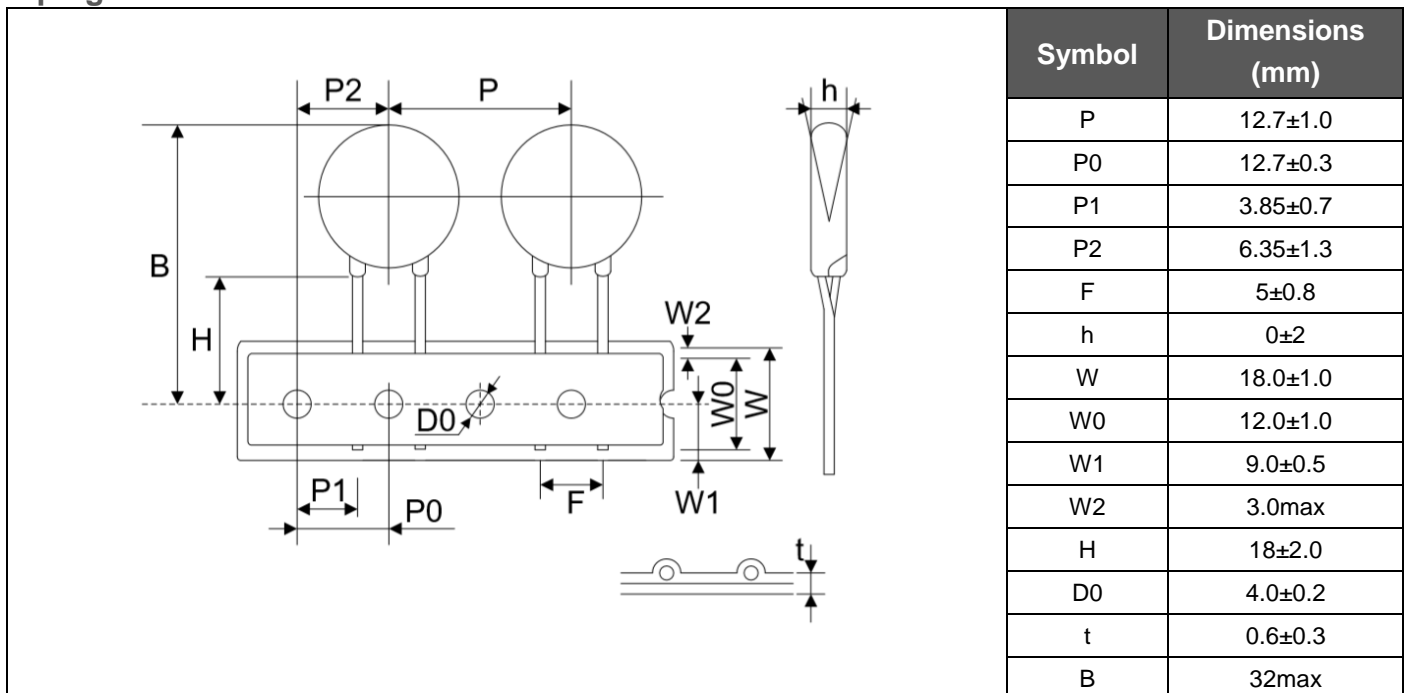

Quantity

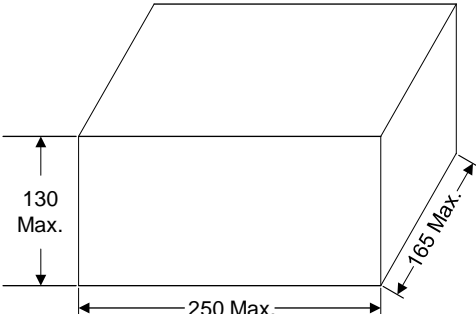
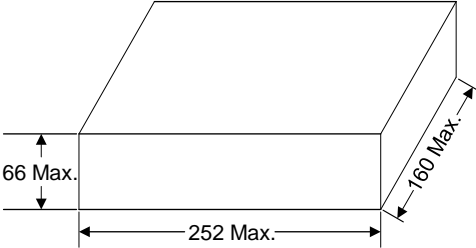
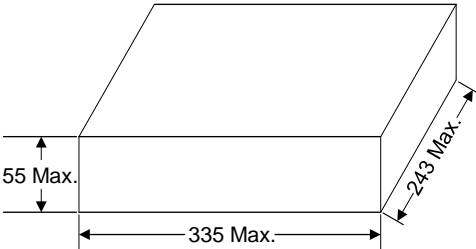
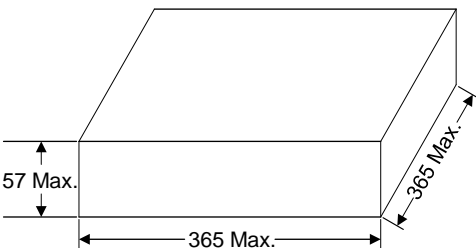
Packaging Dimensions (Unit: mm)	Quantity	
<p>In bulk for Terminals Untrimmed Products</p> 	1000pcs/bag	4bags/box
<p>In bulk for Terminals Trimmed Products</p> 		
<p>Tape & Box</p> 	1500pcs/bag (180K~391K)	6bags/box
	1000pcs/bag (431K~751K)	
<p>Tape & Reel</p> 	2000pcs/bag (180K~391K)	6bags/box
	1500pcs/bag (431k~751K)	